



FABER

A I R M A T T E R S I

Dishwasher Collection



www.covidsafeindia.com

JEEVAN JAGGA

+91 98103 01515

jeevan@covidsafeindia.com



FABER

2:30

P
F
M

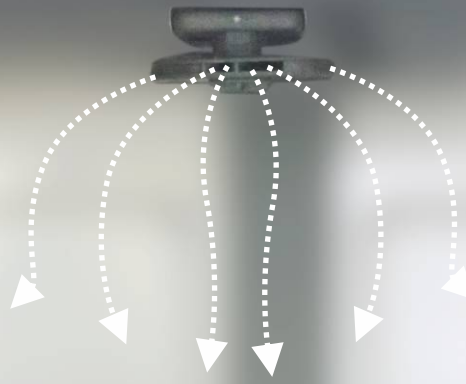

3D Wash Technology

The breakthrough innovative of 3D wash technology uses three spray arms to maximize water spray to all corners of the dishwasher and saves up to 15% time. Exceptional cleaning result in a faster and quieter way.

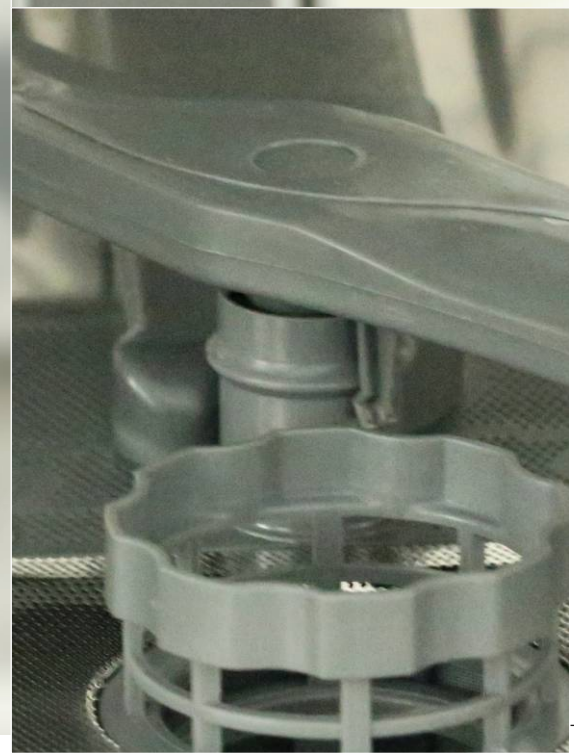
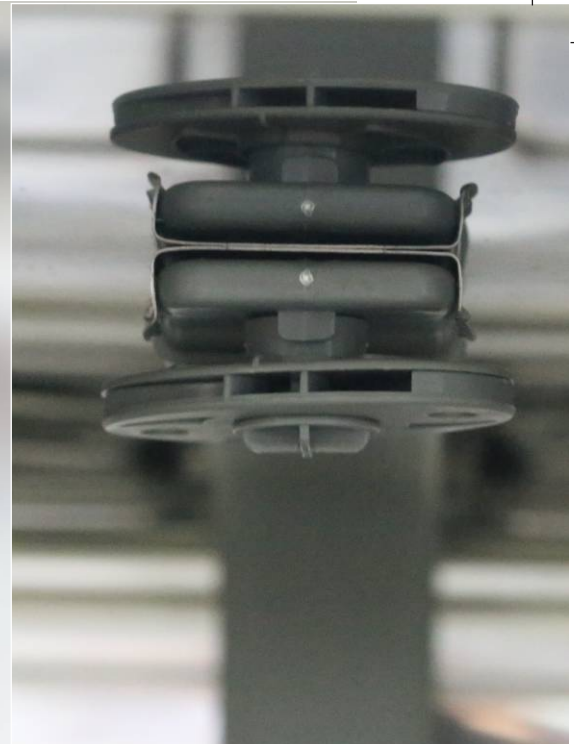
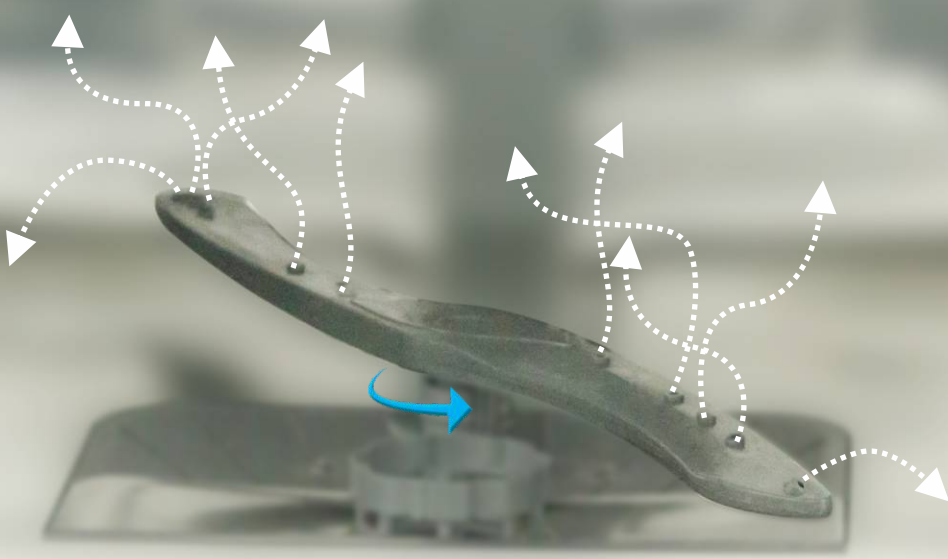
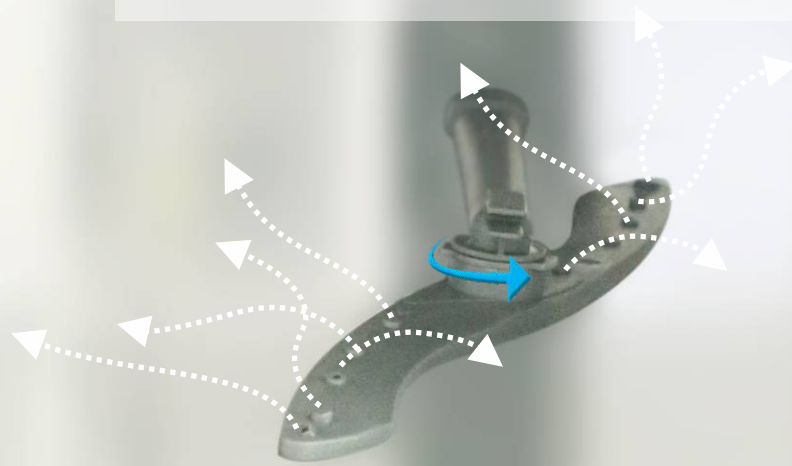

Other Unique Futures

Zone Wash

Upper, lower or both, zone wash provides targeted cleaning in the selected wash zone, so no more waiting to get a full dishwasher load to run a cycle.



Half Load

Less resource consumption with half load option. No longer need to wait for a fully loaded dishwasher to start the cleaning.



Delay Start

With the delay start function you can set your dishwasher to start around your schedule.

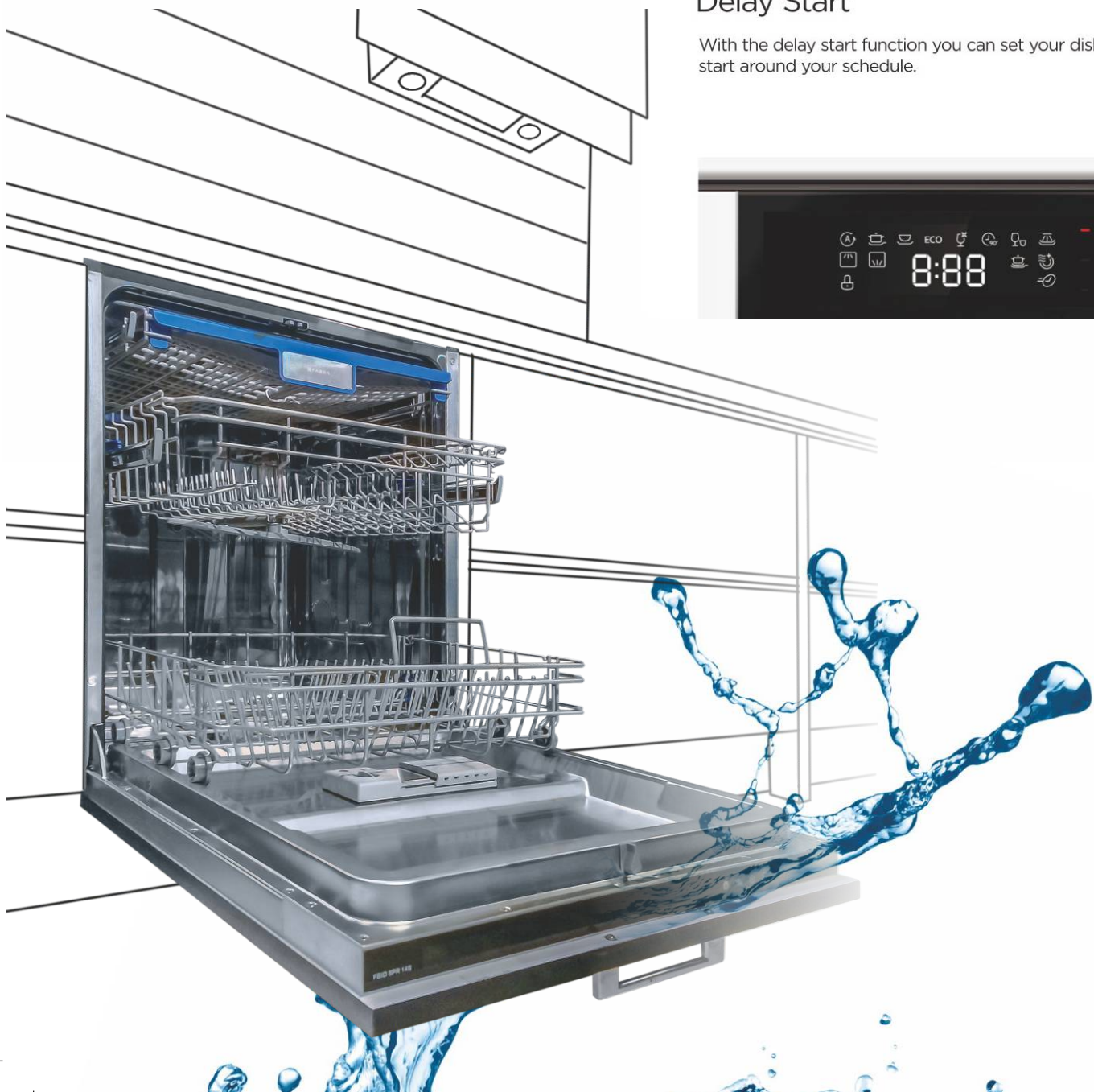

Other Unique Futures

Infinite Plus Cutlery Drawer

Our new cutlery drawer is more flexible and safer than ever.

Not only slidable to provide extra space for tall utensils in the middle rack but now also foldable.

The moving part of the tray can now be lowered for offering extra room for coffee mugs, egg beater, etc, while providing easy access to silverware.



Height-adjustable Basket

More room can be created with the height-adjustable upper basket to accommodate tall stemware in upper basket or extra large bakeware in lower basket.



Soft Close Baskets

Smooth, quiet, and secure close of the basket with the soft close feature, so no more banging and knocking of the baskets on the tub.

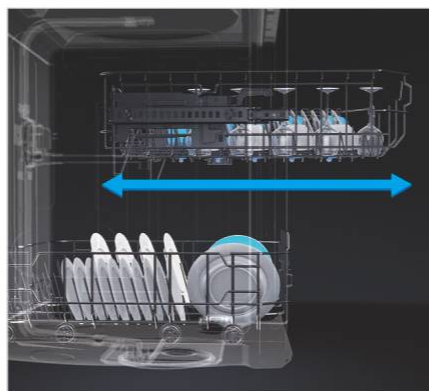

Glide Rail

The ball bearing basket slides are designed for smooth glide in and out of the baskets with loads as heavy as 9 kg. With just simple push or pull the baskets can easily move in the way you want.





FFSD 6PR 12S



FEATURES:

- 12 Place capacity
- White Finish
- Half load
- Height adjustable upper rack and foldable racks
- Power Memory
- Electronic Push button control
- Display
- Natural Drying
- 1-24 hours Delay
- Salt and rinse aid indicators
- Electronic Aqua Stop

SPECIFICATION:

- A++/A/A (energy, cleaning, drying)
- 6 Washing Programs: Intensive, Normal, Eco, 90min, Glass and Rapid.
- Product Dimension (H*W*D mm): 845*598*600



Capacity
(Place Settings)



Delay Start



Half Load



Energy Save



Washing Programs:



Intensive



Normal



Eco



90 min



Glass



Rapid

DISHWASHER: 60CM FREESTANDING



FFSD 8PR 14S



FEATURES:

- 14 Place capacity
- SS Finish
- Dual Zone Wash
- Height adjustable upper basket (after loaded) and foldable Racks
- Multifunction Three Layer Cutlery Basket
- Power Memory
- Child safety Lock
- Power wash/Extra drying/Express
- LED Display
- Natural Drying
- 1-24 hours Delay
- Electronic Push button control
- Salt and rinse aid indicators
- Electronic Aqua Stop

SPECIFICATION:

- A+++/A/A (energy, cleaning, drying)
- 8 Washing Programs: Intensive, Normal, Eco, 90min, Glass, Rapid, Soak (Pre-Wash) and Auto Wash
- Product Dimension (H*W*D mm): 845*598*600



Washing Programs:

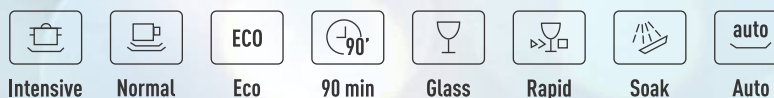

Options:



FSID 8PR 14S

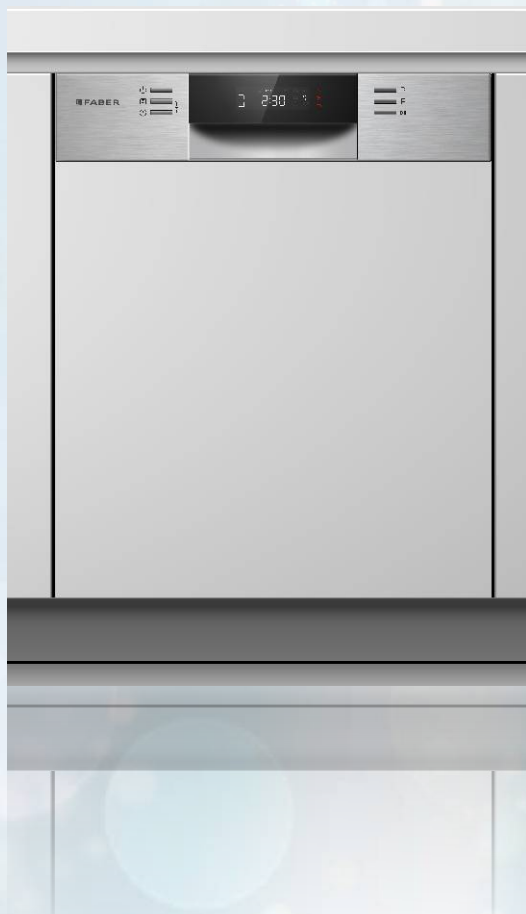

FEATURES:

- 14 Place capacity
- SS Finish
- Dual Zone Wash
- Height adjustable upper basket (after loaded) and foldable Racks
- Multifunction 3rd Layer Cutlery Basket
- Power Memory
- Child safety Lock
- Power wash/Extra drying/Express
- LED Display
- Natural Drying
- 1-24 hours Delay
- Electronic Push button control
- Salt and rinse aid indicators
- Electronic Aqua Stop

SPECIFICATION:

- A+++/A/A (energy, cleaning, drying)
- 8 Washing Programs: Intensive, Normal, Eco, 90min, Glass, Rapid, Soak (Pre-Wash) and Auto Wash
- Product Dimension (H*W*D mm): 845*598*600



Washing Programs:

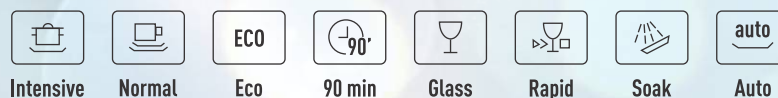

Options:



FBID 8PR 14S



FEATURES:

- 14 Place capacity
- SS Finish Panel
- Dual Zone Wash
- Height adjustable upper basket (after loaded) and foldable Racks
- Multifunction Three-Layer Cutlery Basket
- Power Memory
- Auto Wash
- Extra Drying
- Electronic Touch control
- LED Display
- Natural Drying
- 1-24hours Delay
- Salt and rinse aid indicators
- Electronic Aqua Stop

SPECIFICATION:

- A++/A/A (energy, cleaning, drying)
- 8 Washing Programs: Intensive, Normal, Eco, 90min, Glass, Rapid, Soak (Pre-Wash) and Auto Wash
- Product Dimension (H*W*D mm): 815*598*550

Capacity (Place Settings)	Third Layer (Cutlery Basket)	Delay Start	Auto Wash	Dualzone Wash	Noise Level 44dB	Extra Drying	Super Drying	Energy Save

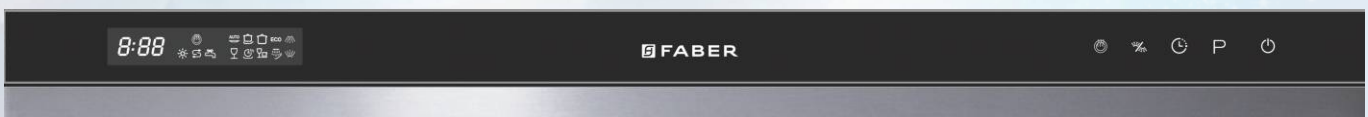









Washing Programs:

Intensive	Normal	Eco	90 min	Glass	Rapid	Soak	Auto



Options:

Extra Drying

Washing Programs:

-  **Auto:** Automatically needed determine the water and cleaning time needed.
-  **Normal:** Everyday dish cleaning makes easy with normal wash.
-  **Eco:** The most efficient program in terms of combined energy and water consumption to clean normally soiled kitchenware.
-  **Heavy / Intensive:** The program for heavy soiled or dried-on stuff kitchenware.
-  **Rapid:** A shorter program for quick wash of lightly soiled loads.
-  **Soak:** Cold pre-wash only to rinse away the food residuals on the pans and dishes awaiting completion of the load.
-  **90 min:** The program for normally soiled kitchenware with improved cleaning and drying results within 90 min.
-  **Glass/ Delicate:** The program ideal for cleaning glassware.

Options:

-  **Power Wash:** Increase the washing temperature to as high as 69°C and the number of rinsing cycles for the purpose of strong washing.
-  **Extra Drying:** Enhance the drying performance through raising the drying temperature.
-  **Express:** Shorten the time of the washing cycle through increased washing temperature to realize the purpose of rapid washing.

Installation Daigram:

FBID 8PR 14S

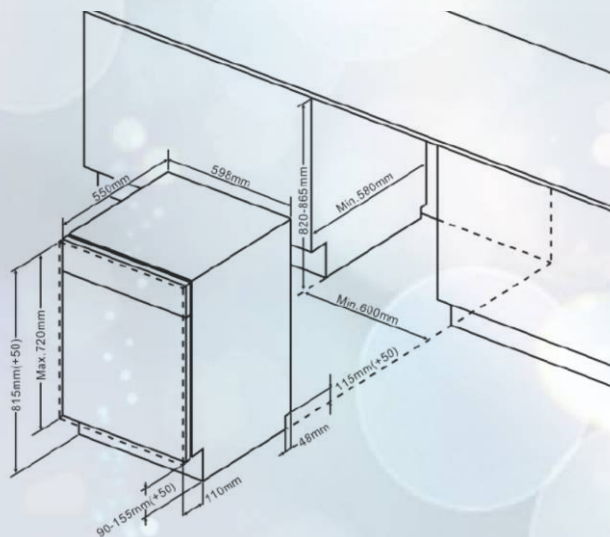

FSID 8PR 14S/FFSD 8PR 14S/FFSD 6PR 12S

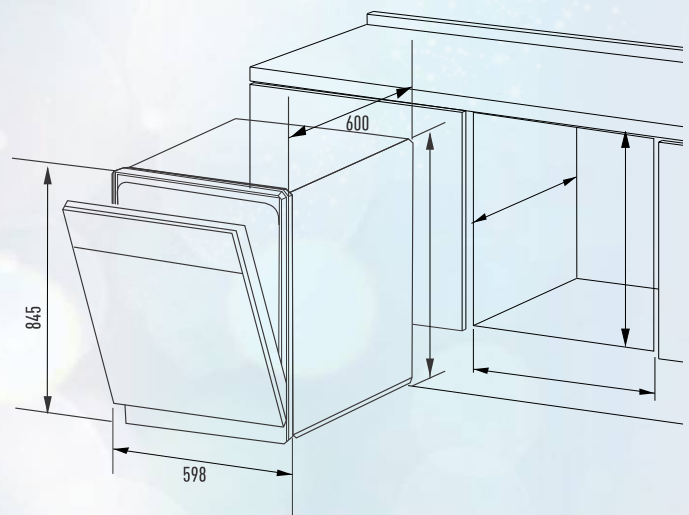

www.covidsafeindia.com



Jeevan Jagga

Founder & CEO

+91 98103 01515

jeevan@covidsafeindia.com

C  **VID**
SAFE INDIA

The logo for COVID Safe India features a central blue virus-like icon with a white cross in the center. This icon is surrounded by various green and blue icons representing health, safety, and community, including a house, a person, a handshake, a biohazard symbol, and a leaf.